

1 PROGRAMMING

1) Program the motor using a standard transmitter as per the quick reference guide

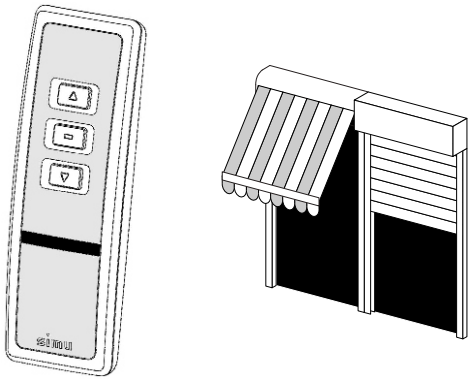

2) Press the programming button on the standard transmitter until the motor jogs up/down

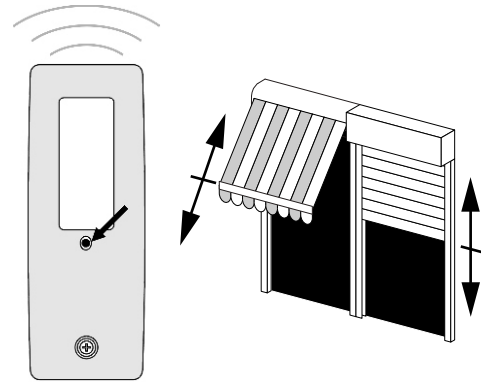

3) Touch the programming contact on the back of the Key Chain Transmitter with a metal conductor (paper clip). The LED on the front will start to flash

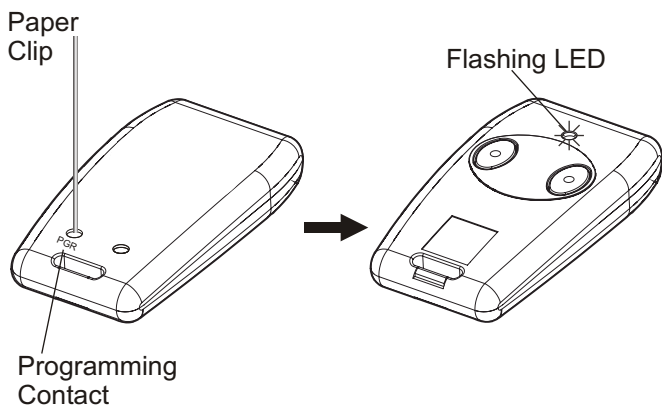

4) Press the desired front button while the LED is still flashing. The motor will jog. This button will now control the motor.

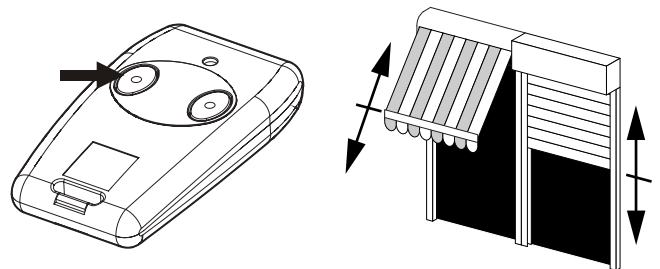

Repeat steps 1 through 4 for other buttons to other motors if desired.

Note: Only program one motor per button. The 2 channel key chain can be used to control 2 motors maximum and the 4 channel can control 4 motors maximum

2 LOCKING/UNLOCKING TSA 4

A - Enabling the locking function - Once a locking code has been entered the TSA 4 will automatically lock the buttons after 2 minutes without a command to prevent unintended operation. The buttons can be unlocked as per section B.

1) Press the lock button for 5 seconds

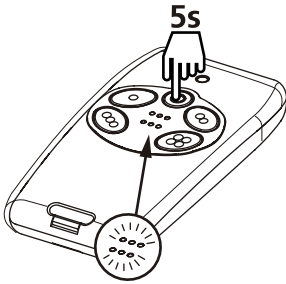

2) Enter a 4 key code

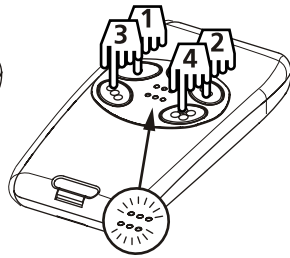

3) Validate the code by pressing the lock button

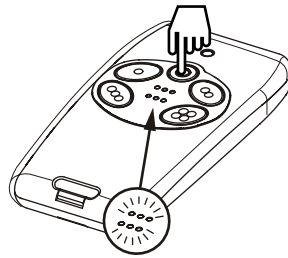

4) Enter the same 4 key code again

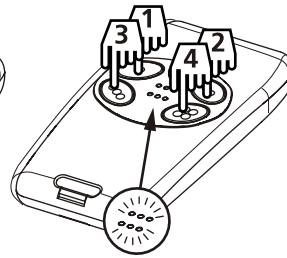

5) Validate the code by pressing the lock button

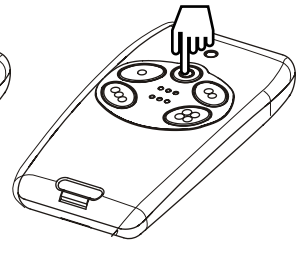

B - Unlocking the remote - After unlocking the remote, the buttons will remain active for 2 minutes before locking again.

1) Enter your 4 key code



2) Validate the code by pressing the lock button

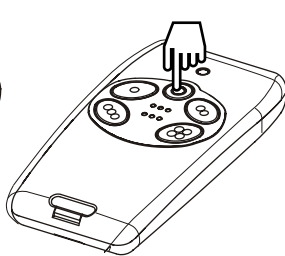

3) The transmitter buttons are unlocked for normal use for 2 minutes. After 2 minutes the transmitter will automatically lock the buttons again

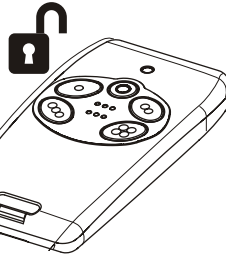

C - Disable the automatic lock function

1) Press the lock button for 5 seconds

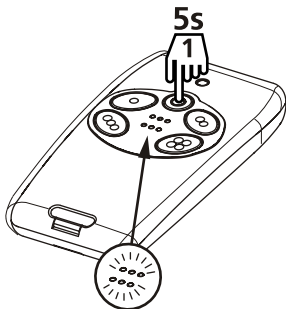

2) After 5 seconds the locking LED will go out. The locking Function is now disabled.

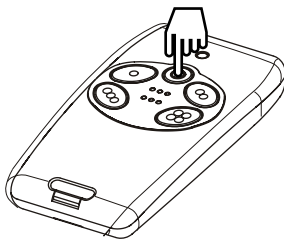

3 REPLACING THE BATTERY

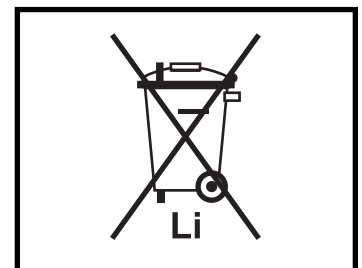
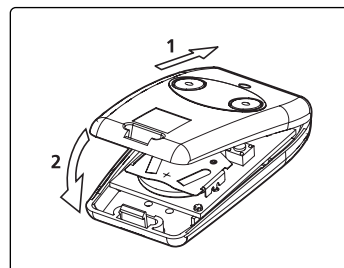
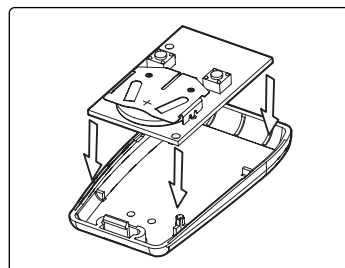
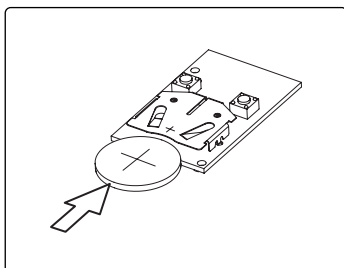
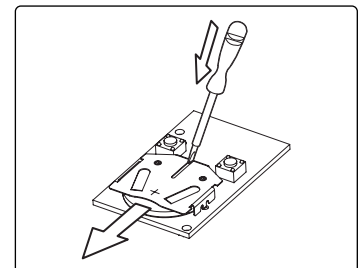
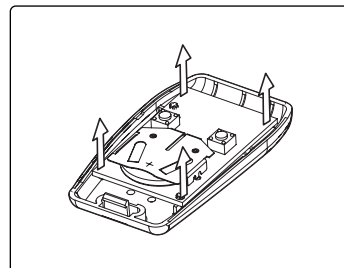
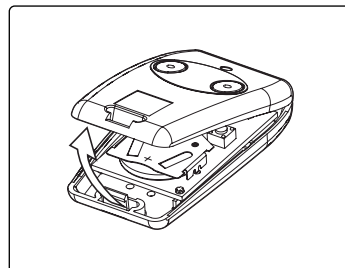
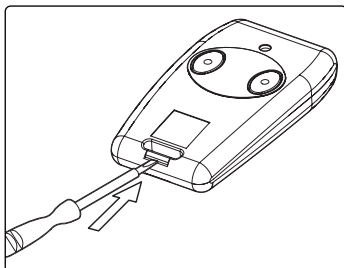

ATTENTION - The battery must be installed correctly with regards to the polarity. The battery must be installed with the + side facing away from the transmitter board. Do not expose battery to high temperatures or water. Do not throw batteries in fire or water. Dispose of batteries correctly